

Features

- APD with 0.2 mm² active area
- 500 μm diameter active area
- High gain at low bias voltage
- Fast rise time, low capacitance
- Optimum gain: 50-60

Description

Circular active area APD chip with 500μm diameter. Ceramic carrier type non hermetic SMD package with clear glass. Reflow solderable.

Application

- Laser range finder
- High speed photometry
- High speed optical communications
- Medical equipment

RoHS

2011/65/EU

Absolute maximum ratings

Symbol	Parameter	Min	Max	Unit
T _{STG}	Storage temp	-40	100	°C
T _{OP}	Operating temp	-20	70	°C
M _{max}	Gain (I _{PO} = 1 nA)	200		
I _{PEAK}	Peak DC current		0.25	mA

Schematic

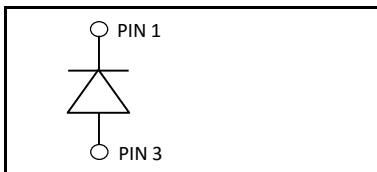

Spectral response (M = 100)

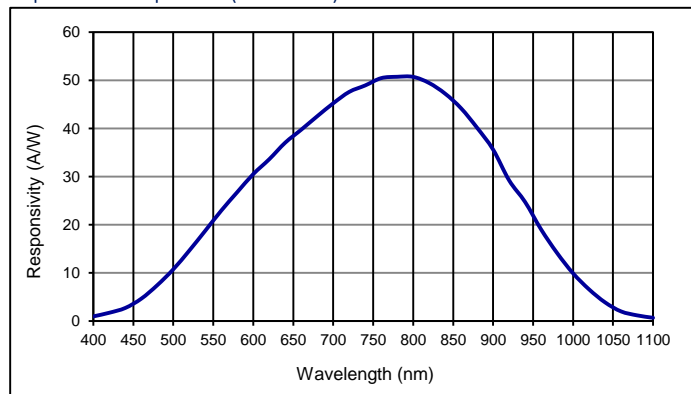

Electro-optical characteristics @ 23 °C

Symbol	Characteristic	Test Condition	Min	Typ	Max	Unit
	Active area		diameter 500			μm
	Active area		0.196			mm ²
I _D	Dark current	M = 100		0.5	1.0	nA
C	Capacitance	M = 100		2.2		pF
	Responsivity	M = 100; λ = 800 nm	45	50		A/W
t _R	Rise time	M = 100; λ = 905 nm; R _L = 50 Ω		0.35		ns
	Cut-off frequency	-3dB		1		GHz
V _{BR}	Breakdown voltage	I _R = 2 μA	80		120	V
	Temperature coefficient	Change of V _{BR} with temperature		0.45		V/K
	Excess noise factor	M = 100		2.2		
	Excess noise index	M = 100		0.2		

Quantum efficiency (23 °C)

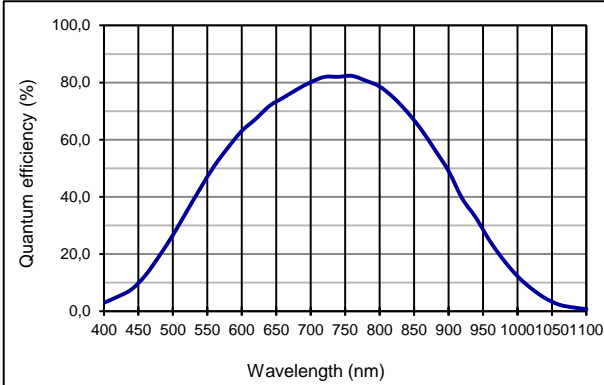

Capacitance as fct of reverse bias (23 °C)

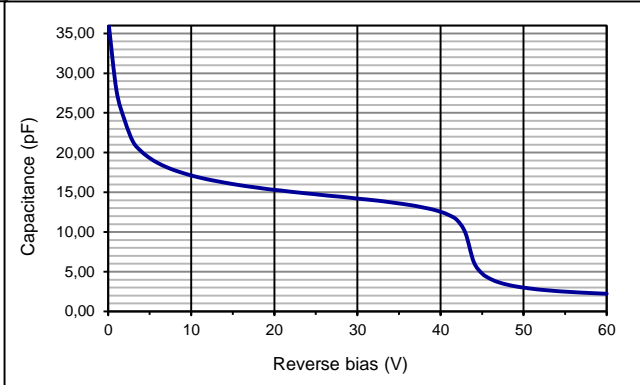

Multiplication as fct of bias (23 °C)

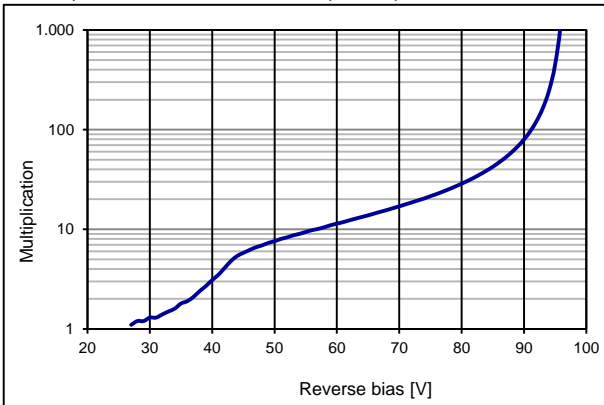

Dark current as fct of bias (23 °C)

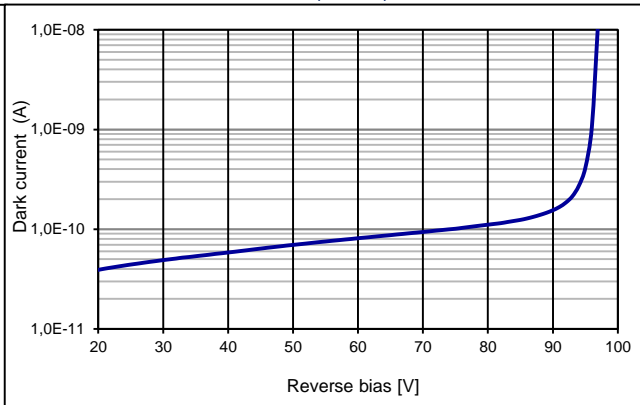

Application hints:

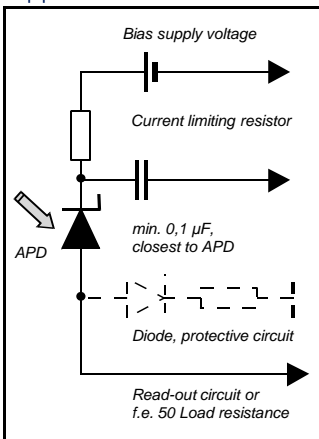

- Current should be limited by a protecting resistor or current limiting - IC inside the power supply
- For low light level applications blocking of ambient light should be used
- For high gain applications bias voltage should be temperature compensated
- Please consider basic ESD protection while handling
- Use low noise read-out - IC
- For further questions please refer to document "Instructions for handling and processing"
- Optimum gain: 50-60

Technical Drawing, Package: LCC6.1

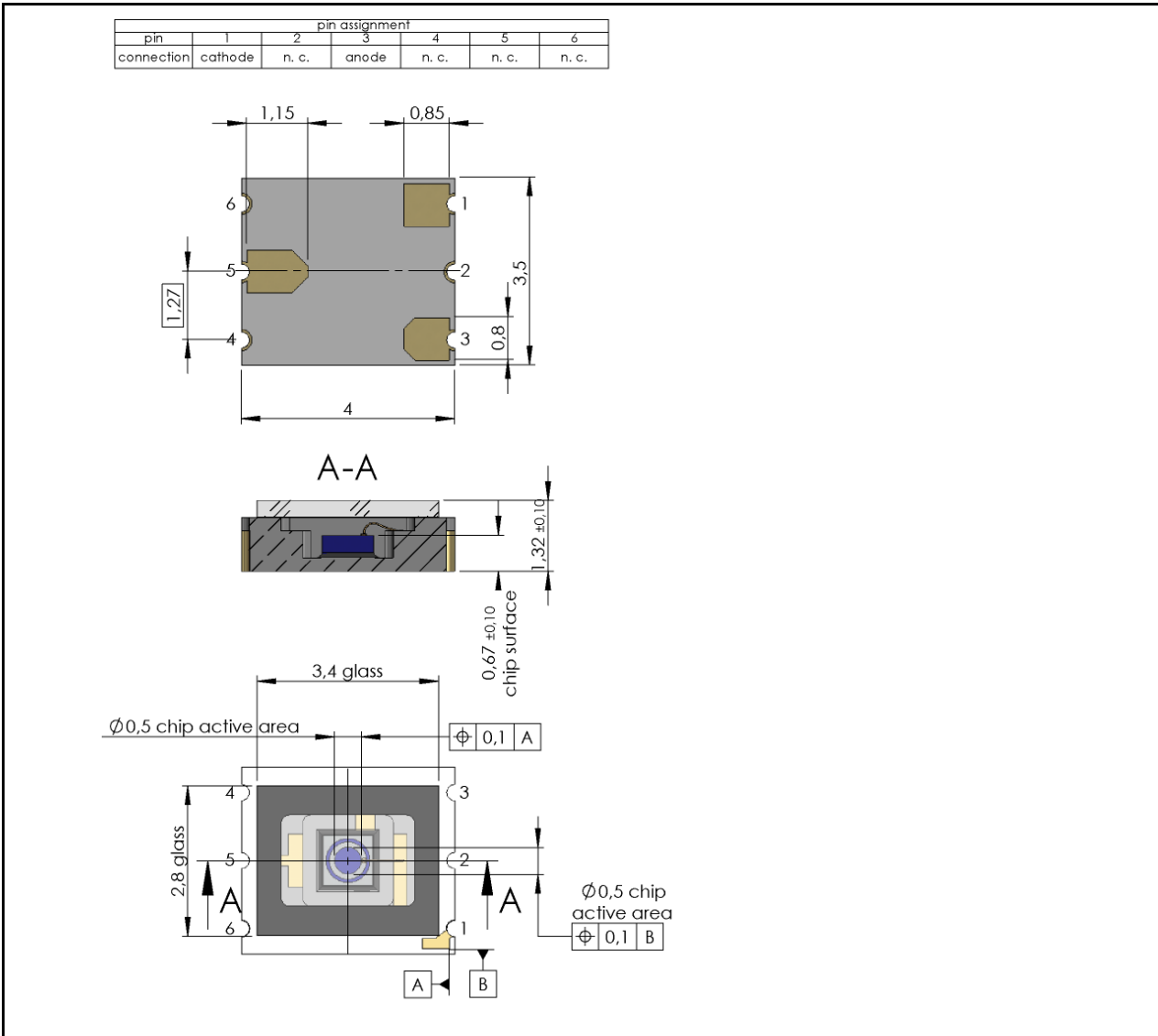

Package dimension, large quantities on reel

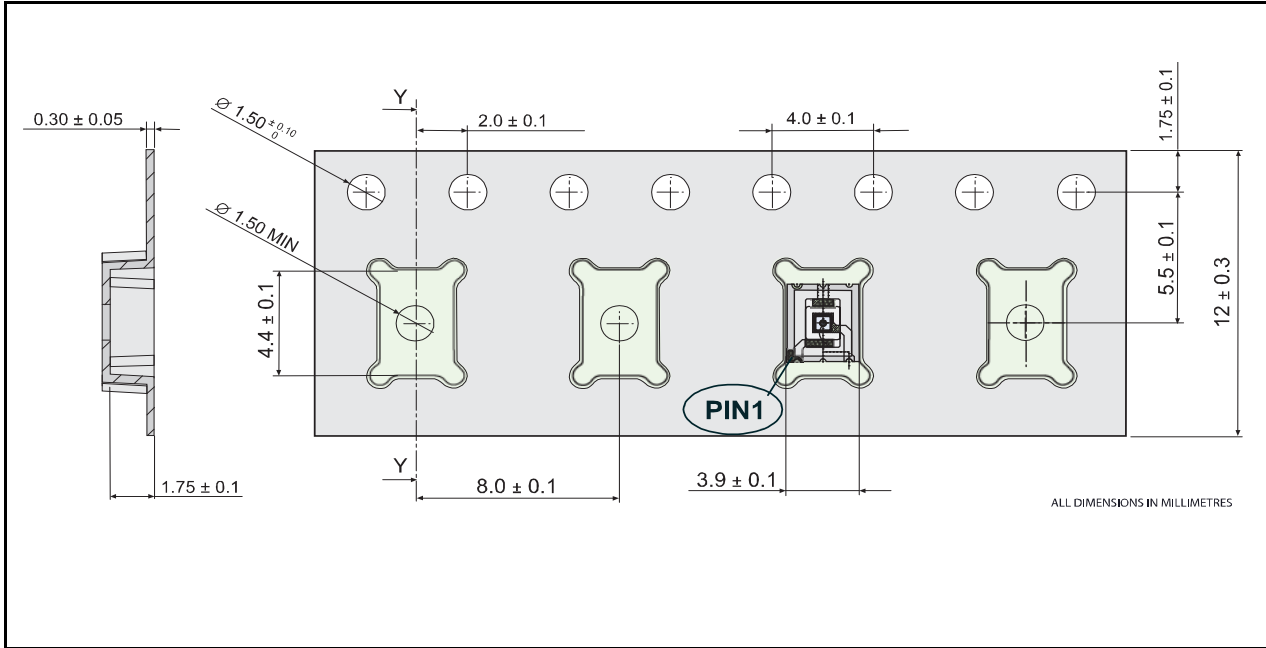

Package dimension, small quantities in trays

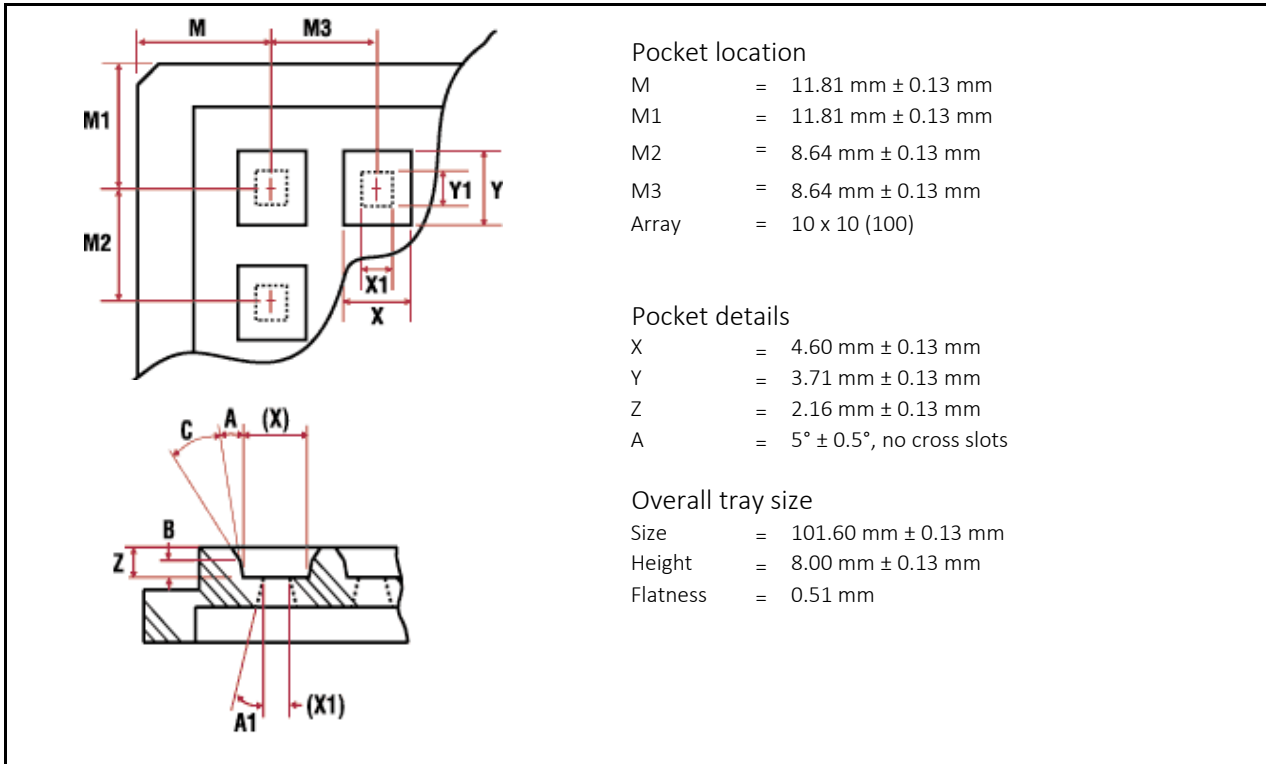

Disclaimer: Due to our strive for continuous improvement, specifications are subject to change within our PCN policy according to JESD46C.